

A PERFECT ALLIANCE.

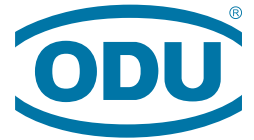

ODU AMC[®] HIGH-DENSITY

Innovation in a compact package.

MINIATURE CONNECTORS



A PERFECT ALLIANCE.



A PERFECT ALLIANCE.

ODU GROUP OVERVIEW

- More than 75 years of experience in connector technology
- A turnover of 170 million Euro
- Over 1,900 employees worldwide
- 9 sales subsidiaries in China, Denmark, France, Germany, Italy, Japan, Sweden, the UK and the US as well as 5 production and logistics sites
- All technologies under one roof: Design and development, machine tool and special machine construction, injection, stamping, turning, surface technology, assembly and cable assembly

As of February 2018

CERTIFIED QUALITY

- DIN EN ISO 9001
- IATF 16949
- DIN EN ISO 14001
- ISO 13485
- Wide range of UL, CSA, VG and DVA licenses
- UL certified cable assembly

For a complete list of our certifications, please visit our website.

CUSTOMER-SPECIFIC SOLUTIONS

Contacts, connectors and integrated cable assembly solutions meeting the most demanding technical market requirements – ODU's connector solutions and value-added services are characterized by their exclusive focus on meeting the customer's needs.

- Precise implementation of application-specific requirements regarding design, functionality, cost and exclusivity
- Custom connector solutions derived from standard products
- One-to-one local expertise and fair, friendly consulting
- Quick prototyping and production turnaround

All dimensions are in mm. Some figures are for illustrative purposes only. Subject to change without notice. Errors and omissions excepted. We reserve the right to change our products and their technical specifications at any time in the interest of technical improvement. This publication supersedes all prior publications. This publication is also available as a PDF file that can be downloaded from www.odu-connectors.com.

Data transmission protocols

These ODU specific connectors can transmit common data transmission protocols such as USB® 2.0 and USB® 3.1 Gen1, but they are not USB®-standard connectors.



CREATING CONNECTIONS, BUILDING ALLIANCES, COLLABORATING INTO THE FUTURE



Dr.-Ing. Kurt Woelfl

Managing Director

Corporate Development, Engineering, Finance/Controlling, Human Resources, IT & Business Processes, Production, Quality Management, Research & Development, Supply Chain Management

Denis Giba

Managing Director

Corporate Communications/Marketing, Corporate Development, Portfolio Management, Sales

TECHNOLOGY THAT UNITES – CONNECTIONS THAT INSPIRE

For over 75 years, this commitment has enabled us to innovate and provide solutions that respond to continuously changing market needs. We provide high-quality electrical connectors that create added value for our customers and any market player seeking a reliable connector solution to enable the transmission of power, signals, media and data transmission.

A PERFECT ALLIANCE is our guiding principle. It represents the synergy between our high-quality connector solutions and the strong partnerships we build with our staff and business partners across the globe – partnerships based on trust, reliability and mutual respect.

ODU is one of the world's leading suppliers of connector systems today, employing over 1,900 people worldwide and generating approximately €170 million in sales. To ensure the very highest quality standards in our cutting-edge products, we continuously invest in their development and production – and ultimately, in our very unique expertise. Over the past few years, our development of customer- and application-specific connectors has led to the sustained growth of our standard product range so that today, we cover a broad range of application areas. A balance between project-specific business, including customized developments, and standard connector design will continue to shape our business into the future. This holds true

for emerging and future markets, such as medical, military and security, and energy, as well as for the special requirements of measurement and testing, eMobility and industrial electronics.

A PERFECT ALLIANCE – The future of ODU will continue to find solid ground for growth: in our focus on providing reliable connector solutions for a variety of challenging applications and in our commitment to continuously expanding our technology portfolio. It's what we do and who we are – around the globe. This brochure is an invitation for you to become even better acquainted with ODU, an internationally active technology company devoted to creating high-quality customized connector solutions.

We are actively shaping the future of our company with creativity, imagination and innovation in order to serve our valued customers around the world.

ODU – A PERFECT ALLIANCE.

The Managing Directors:

Dr.-Ing. Kurt Woelfl and **Denis Giba**

MILITARY AND SECURITY – UNCOMPROMISING QUALITY



Whether extreme environmental conditions or high mechanical stress: functionality under the most difficult conditions is a basic requirement for all connector technologies used in military applications.

ODU connectors ensure a fast information flow with robust and reliable high-tech products. We provide connectors in places where the highest security level is the standard.

ODU is involved in many soldier modernisation programmes – worldwide. In this field, connectors must fulfil a number of rigorous criteria including easy-to-use and reliability under the most extreme conditions. ODU connectors meet and often exceed these requirements by providing a reliable connection even in the toughest of situations.

If you are looking for an innovative, robust, secure and reliable connector solution in the military/defence area – ODU is your partner!

ODU SOLUTIONS FOR EVERY DEPLOYMENT SITUATION

ODU AMC®



GROUP VOICE AND DATA RADIO

- Excellent shielding and data transmission up to 10 Gbit



RIGHT-ANGLED CONNECTOR

- Compact design



PERSONAL COMPUTER

- Small and light



NAVIGATION MODULE

- Easy-Clean version



GPS ANTENNA

- Coax Size 0



SOLDIER CONTROL UNIT

- Cable-to-cable connection



VEHICLE ADAPTION

- Robust and reliable

ODU MINI-SNAP®



ODU MINI-SNAP SERIES F

ODU MINI-SNAP SERIES K

ODU MINI-SNAP SERIES B SUPER-SHORTY

ODU AMC[®] HIGH-DENSITY

Miniaturization – the trend towards perfection in the smallest design.

SMALLEST DIMENSIONS

Diameter less than 10 mm (Size 00, 7 contacts)



7 mm

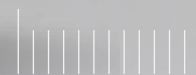
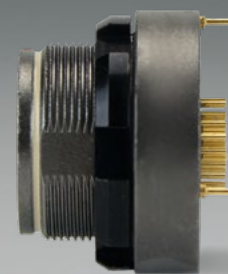

12 mm

fig. approx. 2:1

COMPACT DESIGN

Reliability as well as electrical and mechanical robustness in spite of the compact design

From medical technology to consumer electronics to automotive technology: the trend toward miniaturization continues. High-Density connectors provide the highest possible number of contacts in the most compact space. It gives developers new possibilities and solutions while simultaneously challenging the manufacturer. Because the connectors' reliability and electrical and mechanical robustness must remain intact in spite of the compact size.

ODU created a highly robust miniature connector series that absolutely fulfils these demands: With a diameter of less than 10 mm to 18.5 mm and a contact density of up to 40 contacts, the ODU AMC High-Density series proves that premium quality can also come in small packages. In addition to the High-Density signal connector, the range also includes versions for "Power" (up to 15 A) and "Data Transfer" (USB[®] 3.1 Gen1¹ with 5A power) in the most compact space. The ODU AMC High-Density connectors offer an impressively long service life of more than 5,000

mating cycles even under challenging conditions. Blind mating and optimized mechanical and colour coding ensure reliable and simple handling. Thanks to the Break-Away function, the reliable connection can be released with just a tug on the cable, which makes it possible to change or separate connections in a second.

COMPREHENSIVE MANUFACTURING COMPETENCE FROM ONE SUPPLIER

Miniaturization demands solutions in all manufacturing areas, from the contact technology all the way through to assembly. We consolidate all relevant competencies and key technologies in one company. We offer more than just connectors in the most compact sizes: we also supply the matching system solutions.

Upon request, we will naturally also develop miniature connectors to customer specifications – and consequently create A PERFECT ALLIANCE around the world.

¹ Concerning data transmission protocols please note page 2.

SYSTEM SOLUTION

Innovative options for assembly and extrusion for the cable strain relief

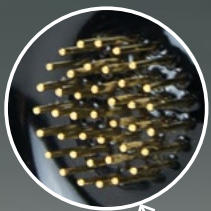

HIGH CONTACT DENSITY

Contact density up to 40 contacts in a minimum design

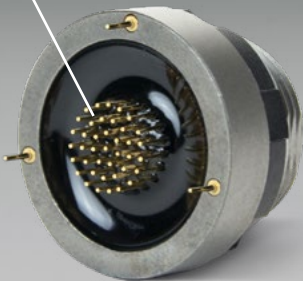

THE EVOLUTION OF MINIATURIZATION

2000

ODU MINI-SNAP® Series K

Size 0/7 contacts/IP 68



2010

ODU AMC®

Size 0/7 contacts/IP 68

45% space savings in comparison with ODU MINI-SNAP series K

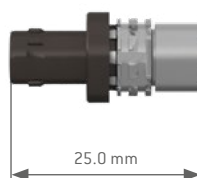

2014



ODU AMC® High-Density

Size 00/7 contacts/IP 68

35% space savings in comparison with ODU AMC series

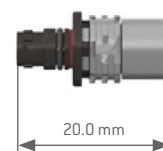

ODU AMC® HIGH-DENSITY AT A GLANCE

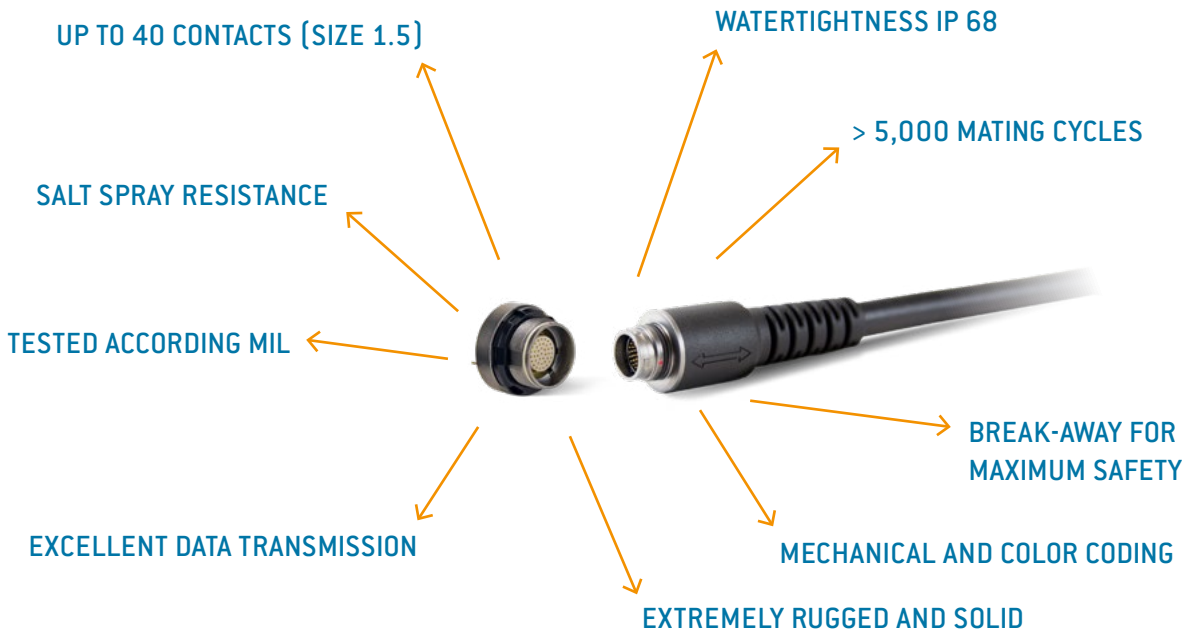

FOUR SHELL SIZES FOR MAXIMUM FLEXIBILITY

SIZE 00

- 2 way
- 4 way
- 7 way
- 4 way USB® 2.0¹



SIZE 0

- 9 way (USB® 2.0¹ + Power)
- 12 way (USB® 3.1 Gen1¹ + Power)
- 16 way (Signal + Data)



SIZE 1

- 27 way (Signal + Data)



SIZE 1.5

- 40 way
- Multi I/O (Signal + Data)



fig. approx. 1:1

PANEL CUT-OUT DIAMETER



¹ Concerning data transmission protocols please note page 2.

ONE PC-BOARD FITS ALL SIZES

All standard sizes can be processed at the same connection level.

This allows us to place signals, data and power in various connector sizes on one PCB height – as a basic requirement for a compact system design.

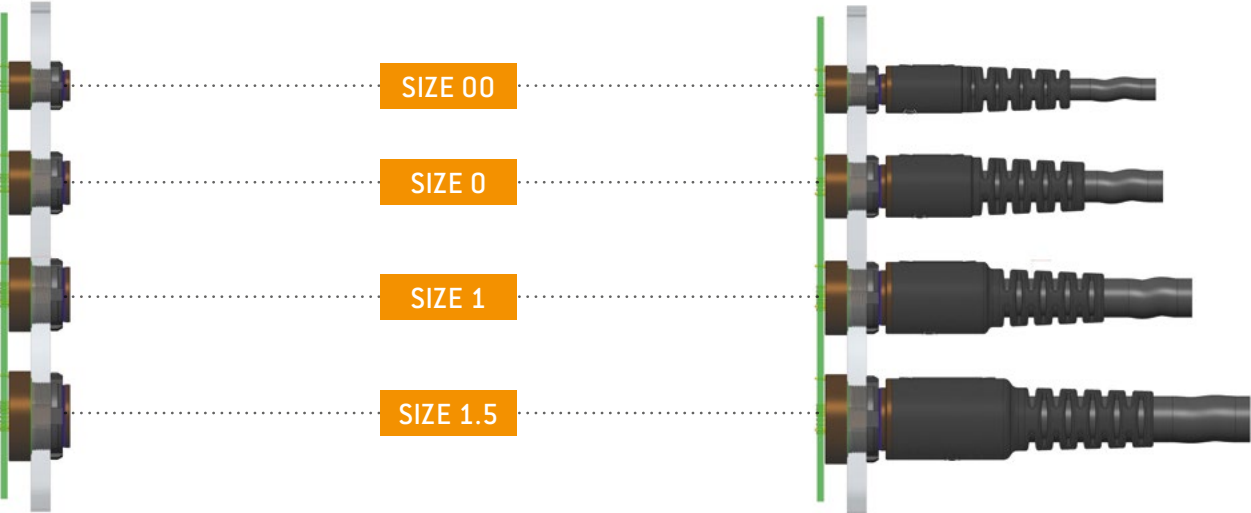

RELIABLE AND ROBUST CODING

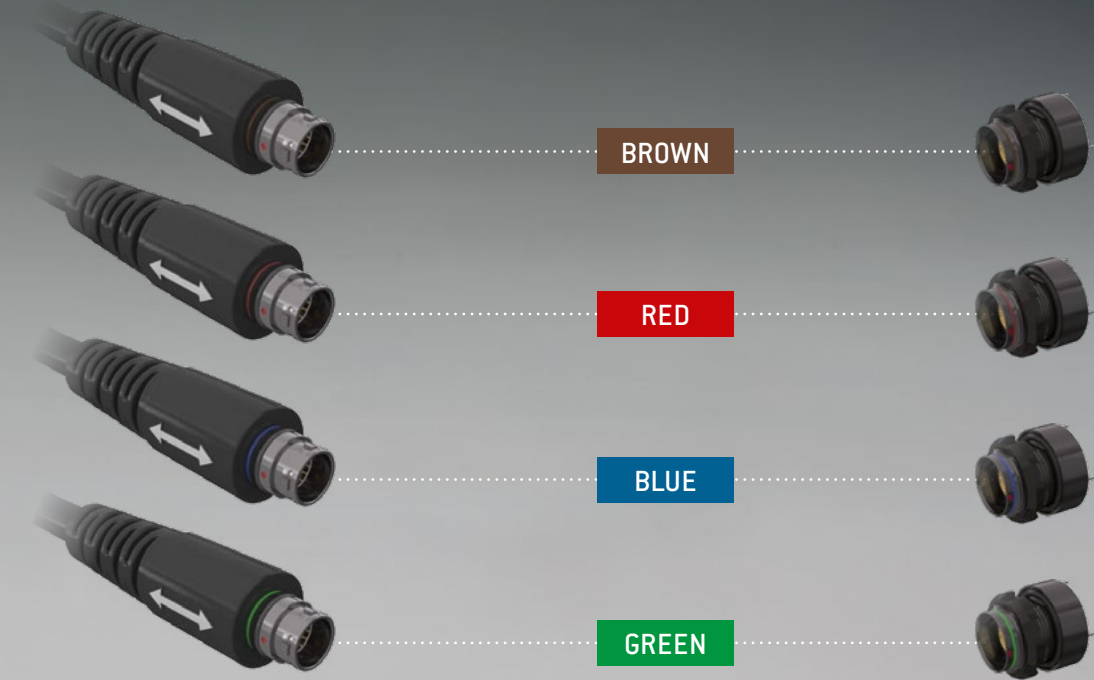

DIMENSIONS AND CONTACT DETAILS

A1: BREAK-AWAY-PLUG

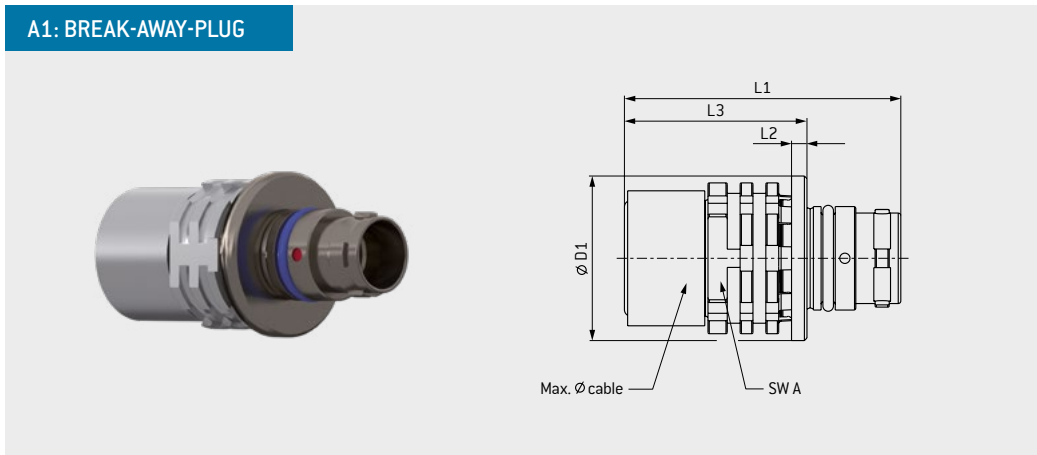

Size	L1 mm	L2 mm	L3 mm	D1 mm	SW A mm	Max. Ø cable mm
00	20.0	1.2	12.8	9.8	8.0	5.0
0	21.5	1.2	14.2	12.8	10.0	7.0
1	25.2	1.2	18.0	14.8	12.0	8.5
1.5	29.2	1.2	22.0	16.8	14.0	10.5

K1: IN-LINE RECEPTACLE

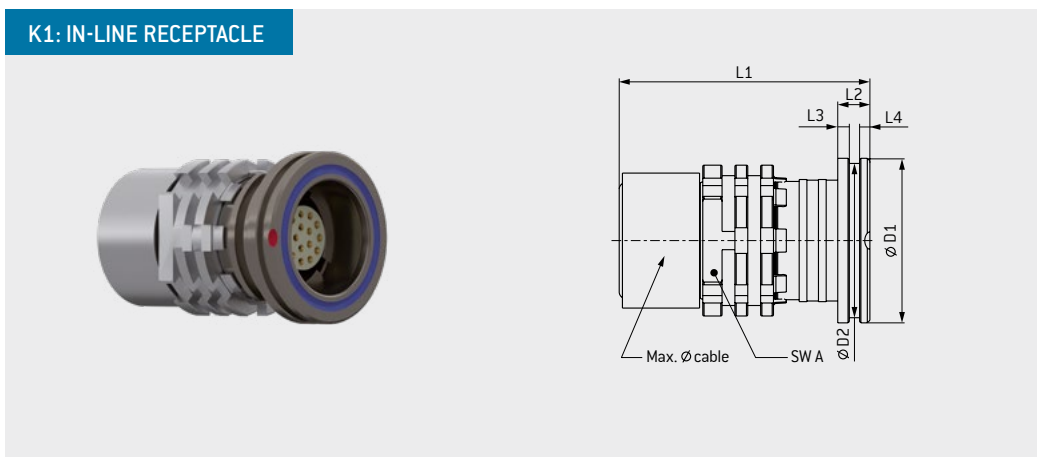

Size	L1 mm	L2 mm	L3 mm	L4 mm	D1 mm	D2 mm	SW A mm	Max. Ø cable mm
00	18.7	2.5	0.8	0.8	9.8	9.0	8.0	5.0
0	19.5	2.5	0.8	0.8	12.8	12.0	10.0	7.0
1	23.5	2.5	0.8	0.8	14.8	14.0	12.0	8.5
1.5	27.5	2.5	0.8	0.8	16.8	16.0	14.0	10.5

DIMENSIONS AND CONTACT DETAILS

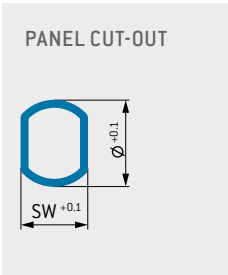
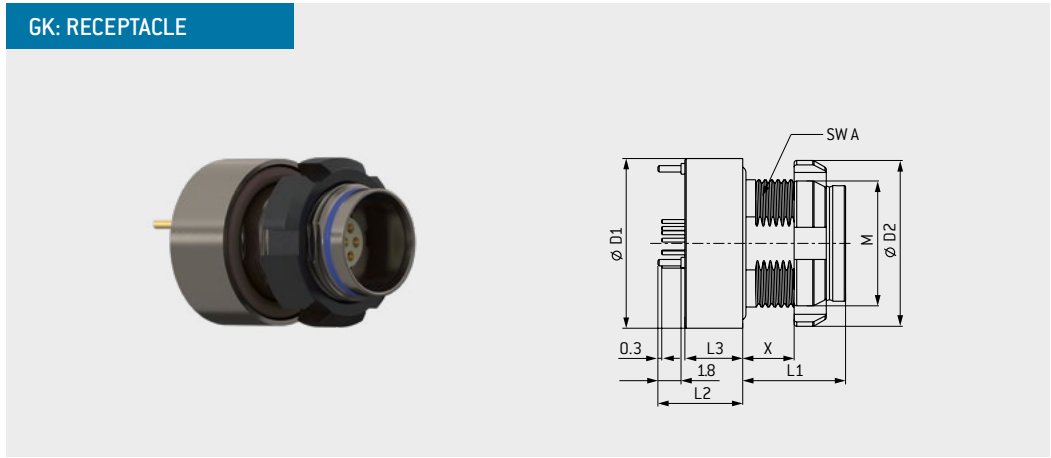

Size	L1 mm	L2 ¹ mm	L3 mm	X max. mm	D1 mm	D2 mm	SW A mm	M mm	Panel cut-out	
									SW mm	Ø mm
00	8.0	6.6	4.5	4.0	10.0	10.0	6.5	7 x 0.5	6.6	7.1
0	8.0	6.6	4.5	4.0	13.2	13.0	9.0	10 x 0.5	9.1	10.1
1	8.0	6.6	4.5	4.0	15.3	15.0	11.5	12 x 0.5	11.6	12.1
1.5	8.0	6.6	4.5	4.0	18.5	18.0	13.0	14 x 0.5	13.1	14.1



¹ For solder cup version: Details on request.

HIGHSPEED DATA TRANSMISSION AT A GLANCE

SIZE 00
 USB® 2.0¹
 480 Mbit/s



SIZE 0
 USB® 3.1 Gen1¹
 5 Gbit/s

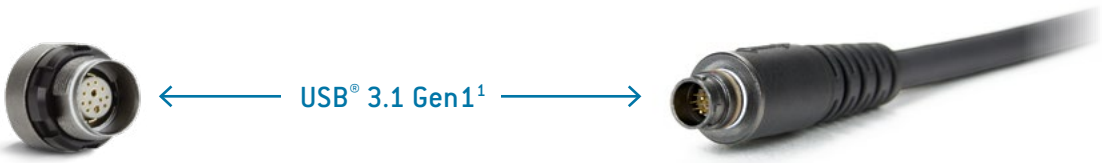

CHARACTERISTIC IMPEDANCE

ODU AMC High-Density connector with 3 m cable in total and 2x USB® 3.1 Gen1¹ Type A connector.

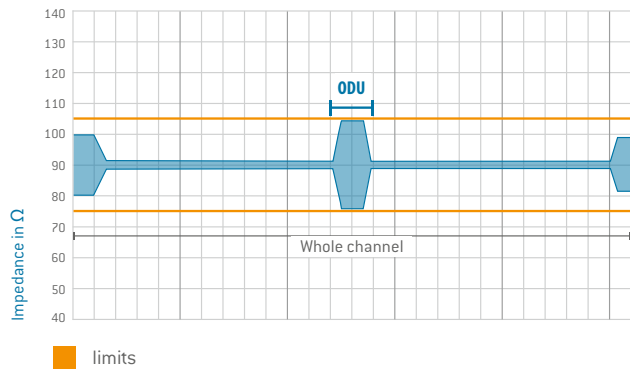



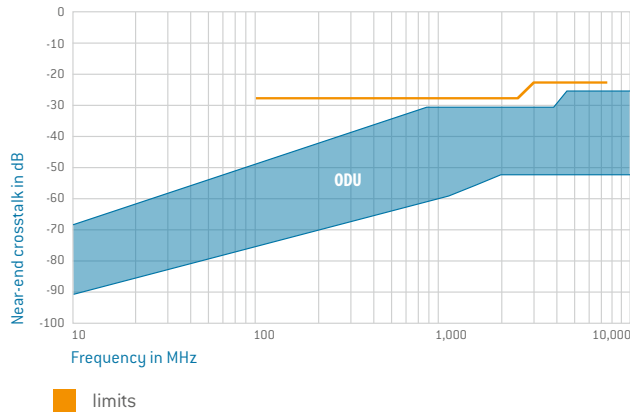

NEAR-END CROSSTALK

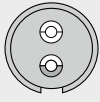

Secure data transmission has become indispensable in military actions.

¹ Concerning data transmission protocols please note page 2.

CONTACT CONFIGURATIONS

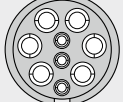
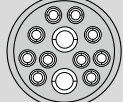
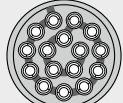
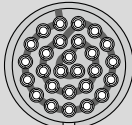
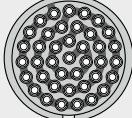
Shell size	Layout	Number of contacts	Suitable for	Termination		Max. wire size Soldercup	Max. current ²	Test voltage acc. SAE 13441	Rated voltage ³
				PCB ¹ only GK style	Soldercup				
00		02	Power	● Ø 0.5	●	2 x AWG 24 (Power)	3 A	1,200	300
		04	Signal	● Ø 0.3	●	4 x AWG 28	1 A	900	300
		04	USB® 2.0 ⁴	0	●	2 x AWG 28 (Signal Lines) 2 x AWG 24 (Power)	1 A 3 A	750	250
		07	Signal	● Ø 0.3	●	7 x AWG 28	1 A	750	250
0		09	USB® 2.0 ⁴ + Power	0	●	3 x AWG 28 (Signal Lines) 6 x AWG 22 (Power)	1 A 5 A	750	250
		12	USB® 3.1 Gen1 ⁴ + Power	0	●	10 x AWG 28 (Signal Lines) 2 x AWG 22 (Power)	1 A 5 A	750	250
		16	Signal	● Ø 0.3	●	16 x AWG 28	1 A	750	250
1		27	Signal	● Ø 0.3	●	27 x AWG 28	1 A	750	250
1.5		40	Signal	● Ø 0.3	●	40 x AWG 30	1 A	750	250

¹ Layouts on request.

² Single contact load.

³ Maximal operating voltage at sea level up to 2000 m acc. To SAE 13441.

For various applications the safety requirements regarding the operating voltage is even more severe.

This must be evaluated during the time of equipment engineering.

⁴ Concerning data transmission protocols please note page 2.

⁰ On request.

SPECIAL APPLICATIONS NEED SPECIAL SYSTEM SOLUTIONS

Every connection also needs its cable. In addition to high quality connectors, ODU also offers a comprehensive assembly service from one supplier. At the connectors side it means innovative options for assembly and extrusion for the cable bend relief, as

well as connections to flex and PCB solutions on the device side. Our component assembly team tests the complete system to our specifications and promises you the same quality found in our connectors – without compromises.



A CONNECTION YOU CAN COUNT ON

- Close cooperation with our customers to find the optimal solution
- ODU handles the complete processing, from procuring the cable and assembly up to individual potting or overmouldings
- 100% inspection
- The connectors are also able to be assembled by customers – supported by the ODU experts



TERMINATION PC-BOARD

ODU AMC High-Density receptacles can be terminated with PC-boards, flex-layers or rigid-flex solutions. The solder process is tested and qualified for all available inserts.

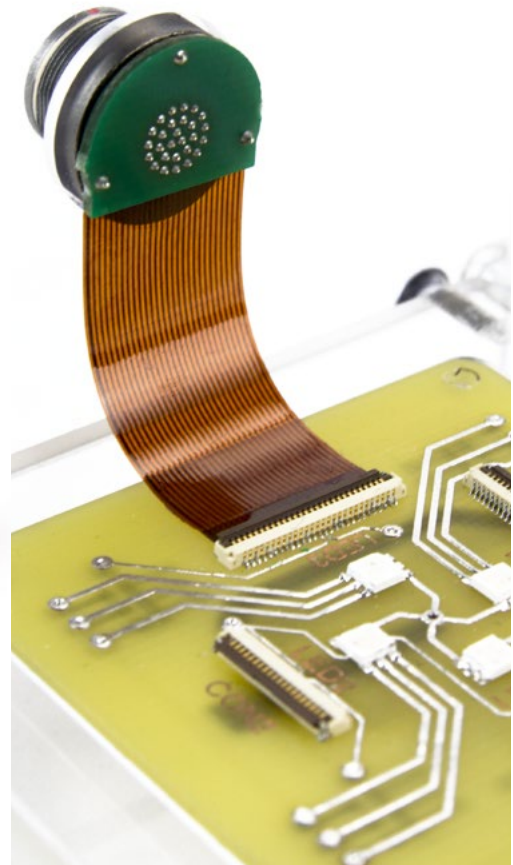
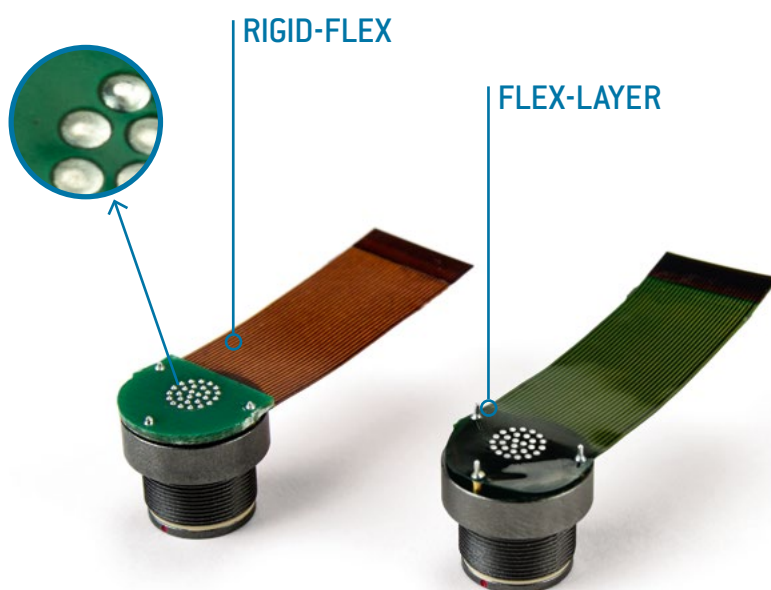

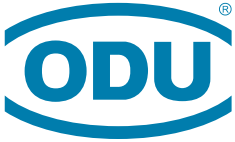

A PERFECT ALLIANCE.

ODU GROUP WORLDWIDE

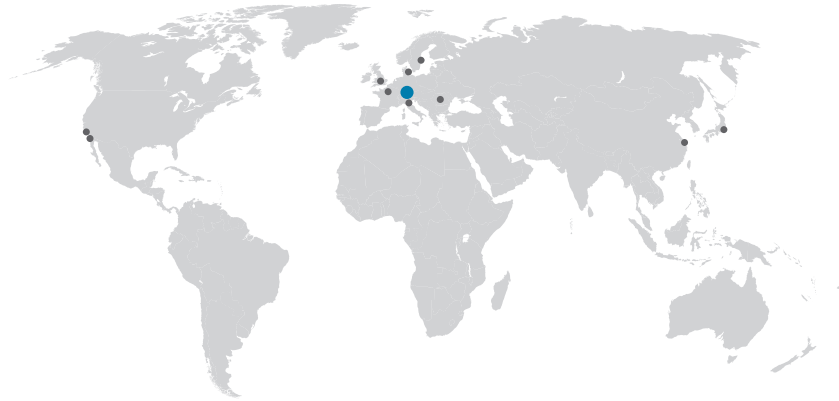

HEADQUARTERS

ODU GmbH & Co. KG

Pregelstraße 11, 84453 Mühldorf a. Inn, Germany
Phone: +49 8631 6156 -0, Fax: +49 8631 6156 -49, E-mail: zentral@odu.de

SALES SUBSIDIARIES

ODU Denmark ApS

Phone: +45 2233 5335
E-mail: sales@odu-denmark.dk
www.odu-denmark.dk

ODU Japan K.K.

Phone: +81 3 6441 3210
E-mail: sales@odu.co.jp
www.odu.co.jp

ODU-UK Ltd.

Phone: +44 330 002 0640
E-mail: sales@odu-uk.co.uk
www.odu-uk.co.uk

ODU France SARL

Phone: +33 1 3935-4690
E-mail: odu@odu.fr
www.odu.fr

ODU Scandinavia AB

Phone: +46 176 18262
E-mail: sales@odu.se
www.odu.se

ODU-USA, Inc.

Phone: +1 805 484-0540
E-mail: sales@odu-usa.com
www.odu-usa.com

ODU Italia S.R.L.

Phone: +39 331 8708847
E-mail: sales@odu-italia.it
www.odu-italia.it

ODU (Shanghai)

International Trading Co., Ltd.
Phone: +86 21 58347828-0
E-mail: oduchina@odu.com.cn
www.odu.com.cn

Further information and specialized representatives can be found at:

www.odu-connectors.com/contact

PRODUCTION AND LOGISTICS SITES

Germany Otto Dunkel GmbH
China ODU (Shanghai) Connectors Manufacturing Co.Ltd
Mexico ODU Mexico Manufacturing S.R.L. de C.V.
Romania ODU Romania Manufacturing S.R.L.
USA ODU-USA, Inc.
ODU North American Logistics



Simply scan the QR code
to download the entire brochure.

GRASWALD HEILIGTAC | Passau

ODU AMC[®] HIGH-DENSITY

AMCHD / B / 0418 / E